

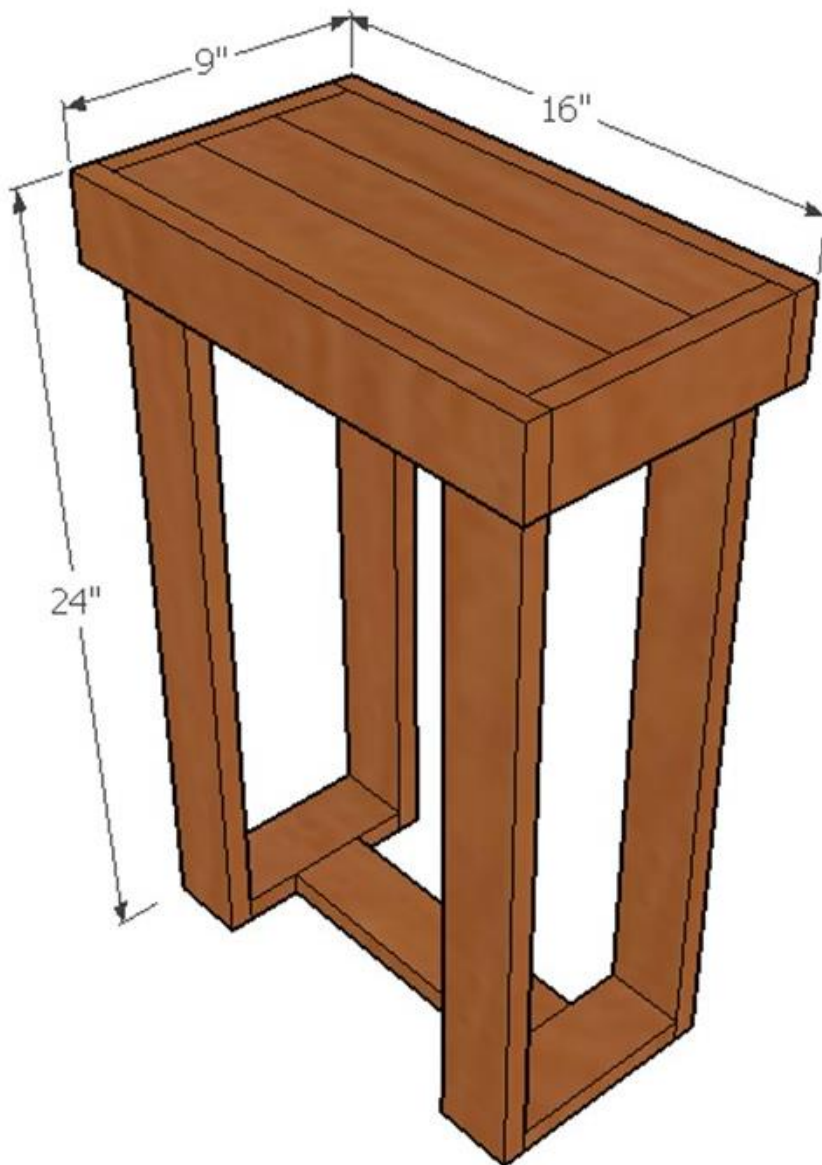

MINI SIDE TABLE



MATERIALS NEEDED:

3 – 1X3X8 BOARDS (TYPICALLY PINE)

24 – 1 ¼” POCKET HOLE SCREWS (IF USING POCKET HOLE JOINERY)

SANDPAPER

WOOD GLUE

STAIN/PAINT/POLY

1 ¼” BRAD NAILS

TOOLS USED:

MITER SAW

DRILL

SANDER

POCKET HOLE JIG (OPTIONAL)

TAPE MEASURE



CUT LIST:



A – LEG POST (4 @ 23 ¼")

B – LEG RAIL (4 @ 6")

C – STRETCHER (2 @ 9 ½")

D – SHORT APRON PIECE (2 @ 7 ½")

E – LONG APRON PIECE (2 @ 16")

F – TOP (3 @ 14 ½")

STEP 1:

CUT LUMBER TO SIZE ACCORDING TO CUT LIST THEN SAND ALL SIDES OF EACH PIECE.

STEP 2:

DRILL TWO POCKET HOLES (TWO IN EACH END) OF ALL OF THE "B" AND "C" PIECES. ENSURE THE POCKET HOLE JIG AND DRILL BIT ARE SET TO DRILL HOLES FOR $\frac{3}{4}$ " LUMBER.

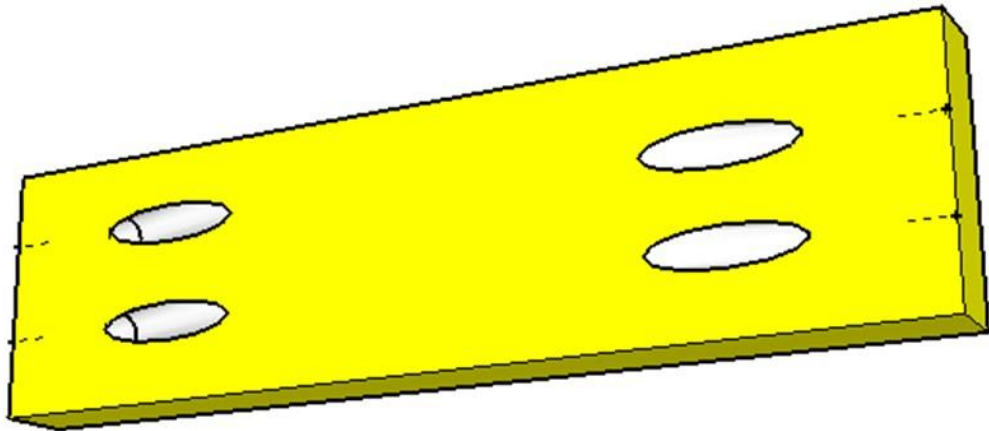

STEP 3:

USING A BUTT JOINT (A BUTT JOINT IS WHEN YOU BUTT ONE PIECE OF WOOD AGAINST ANOTHER), JOIN ONE PIECE "A" TO ONE PIECE "B" USING GLUE AND 1 ¼" POCKET HOLE SCREWS. MAKE SURE THE "B" PIECE IS SITTING ON TOP OF THE "A" PIECE WITH POCKET HOLES POINTING OUT.

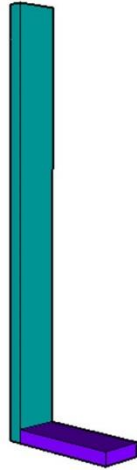

ATTACH THE SECOND "B" PIECE TO THE OPPOSITE END OF THE "A" PIECE. AGAIN, MAKE SURE THE POCKET HOLES ARE POINTING OUT. COMPLETE THE BOX BY ADDING THE SECOND "A" PIECE. REPEAT THIS STEP TO MAKE TWO BOXES.

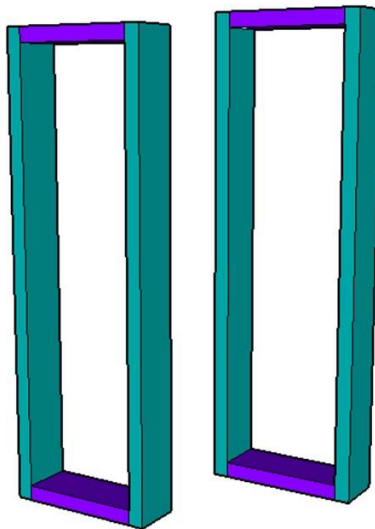

STEP 4:

FIND THE CENTER OF THE SHORT SIDES OF ONE BOX. MAKE A MARK $1\frac{1}{4}$ " ON EITHER SIDE OF THE MIDDLE. ALIGN PIECES "C" ON THE MARKS WITH THE POCKET HOLES FACING OUT AND SECURE WITH WOOD GLUE AND POCKET HOLE SCREWS.

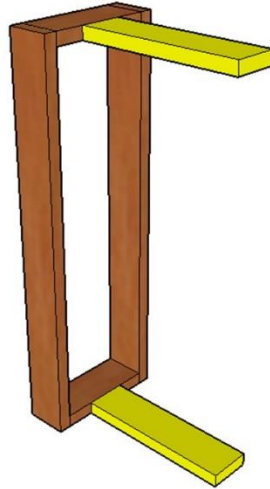

STEP 5:

ATTACH THE SECOND BOX TO THE "C" PIECES IN THE SAME MANNER AS STEP 4 TO CREATE YOUR TABLE BASE.

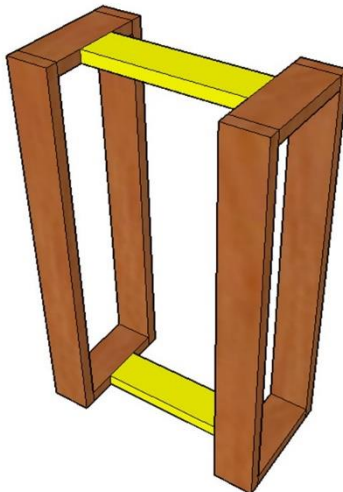

STEP 6:

USING WOOD GLUE, ATTACH THE “F” PIECES TO THE TOP OF THE TABLE BASE AND CLAMP THEM UNTIL THE GLUE SETS.

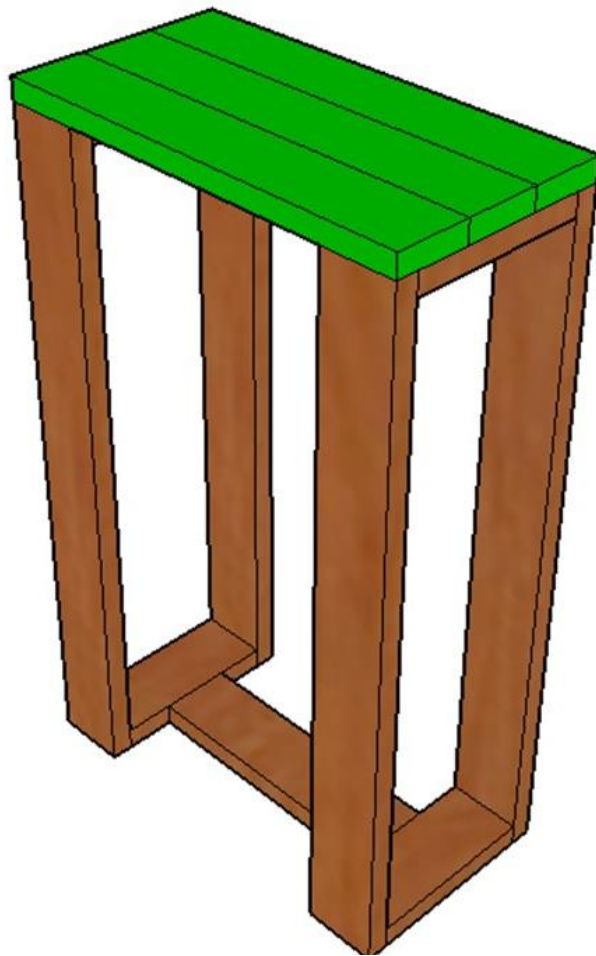

STEP 7:

ATTACH THE "D" AND "E" PIECES USING GLUE AND BRAD NAILS TO THE SIDES OF THE TABLE TOP. ENSURE THAT THE TABLE TOP IS FLUSH.

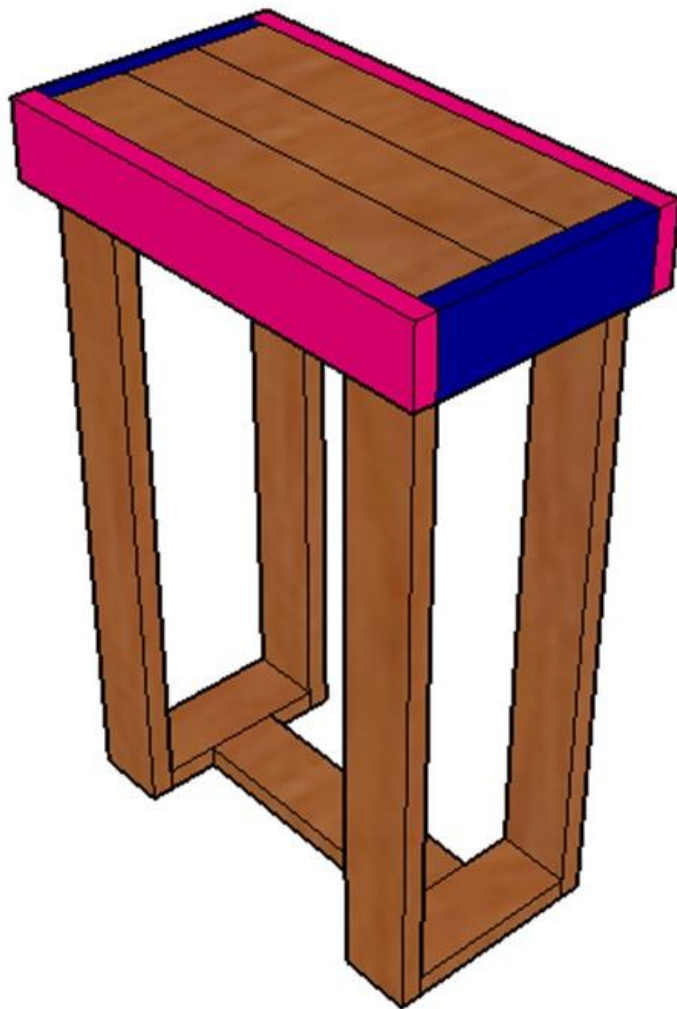

STEP 8:

FINISH THE TABLE AS YOU DESIRE USING PAINT, STAIN, OR A COMBINATION OF BOTH. FINISH WITH A POLY OR OTHER SEALER IF USING STAIN TO PROTECT THE SURFACE.

IF YOU HAVE ANY QUESTIONS, PLEASE CONTACT ME ON INSTAGRAM OR FACEBOOK UNDER THE USERNAME @7MILEDESIGNS OR THROUGH EMAIL — INFO@7MILEDESIGNS.BIZ. IF YOU USE THESE PLANS TO MAKE YOUR OWN TABLE, I WOULD LOVE TO SEE IT SO PLEASE TAG ME IN YOUR PICTURES AND USE THE HASHTAG #7MDMINISIDETABLE!

